

# Draw a Mask

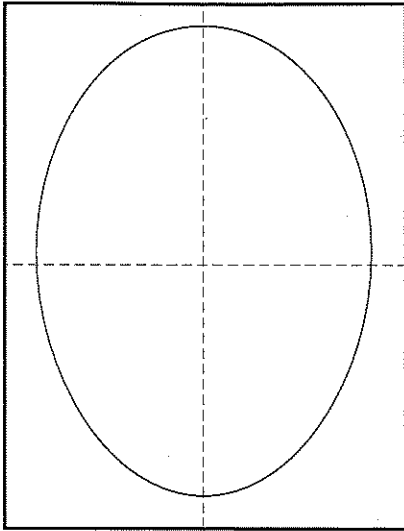

1. Make guidelines. Draw an oval.

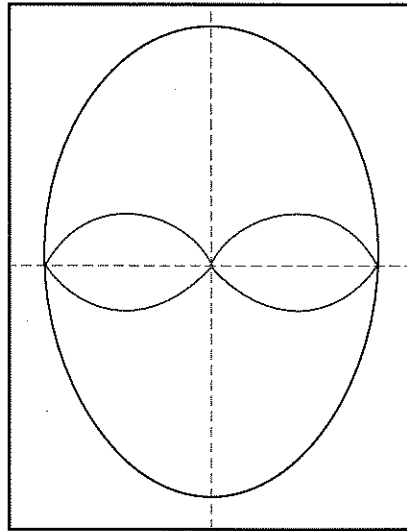

2. Draw two touching eye shapes.

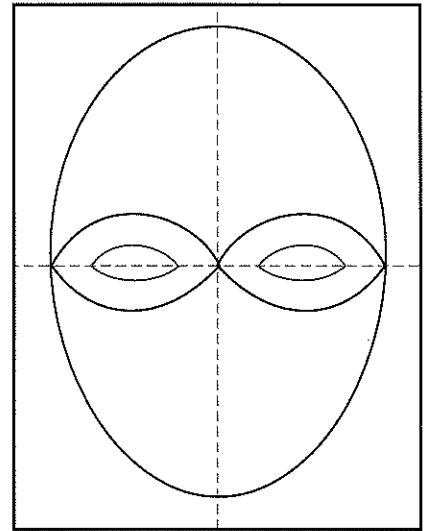

3. Draw two eyes inside.

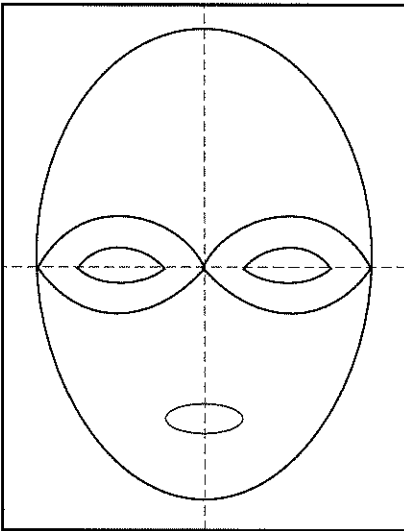

4. Draw an oval mouth.

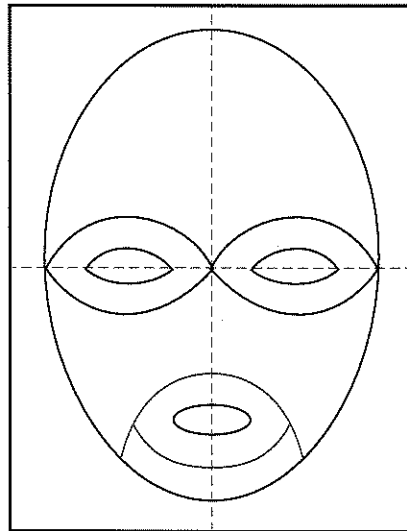

5. Add lines around the mouth.

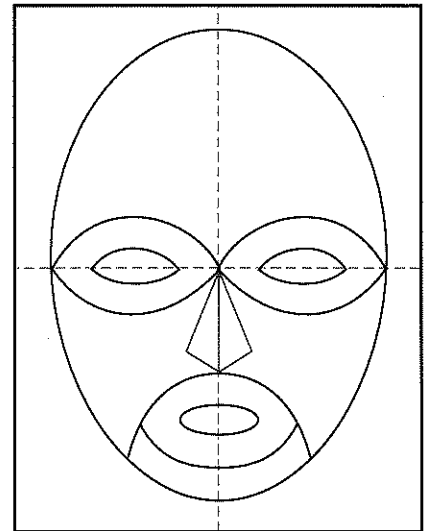

6. Add a nose.

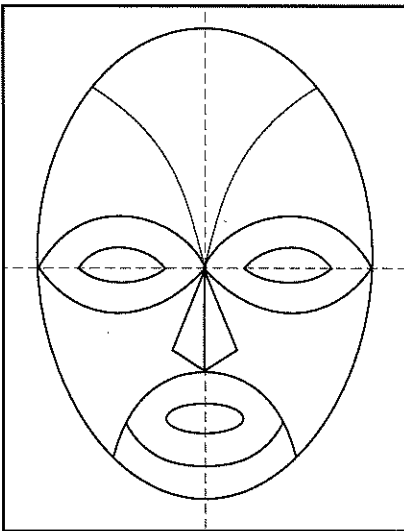

7. Add curved lines in forehead.

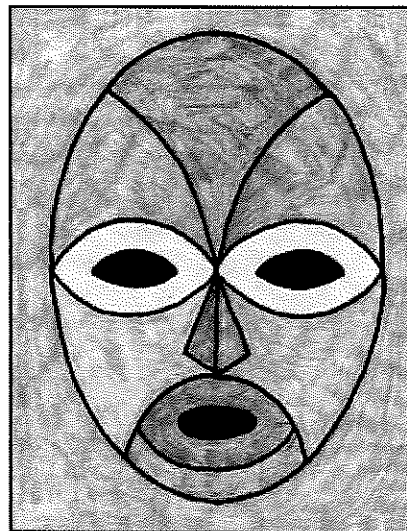

8. Trace and color with crayons.

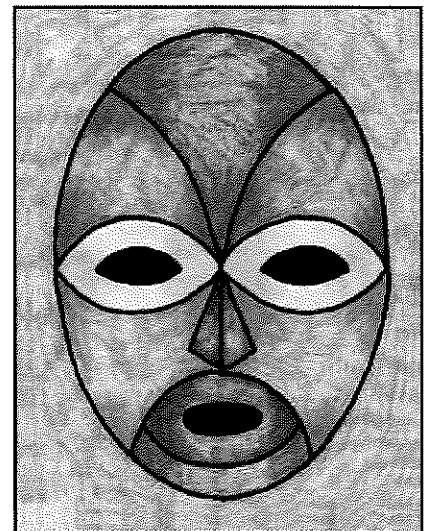

9. Color the corners to darken.

# Draw a Koi Fish

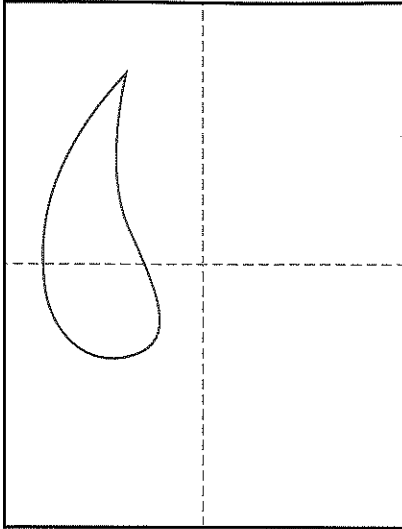

1. Draw a medium teardrop shape.

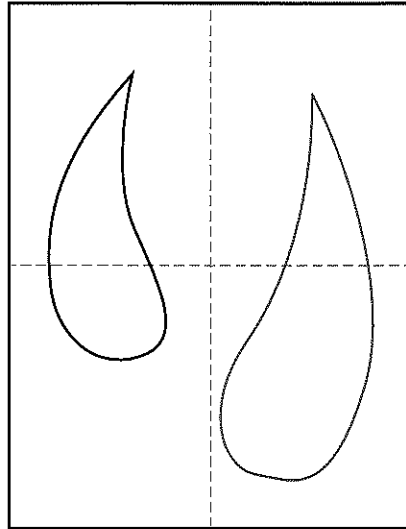

2. Draw a large teardrop shape.

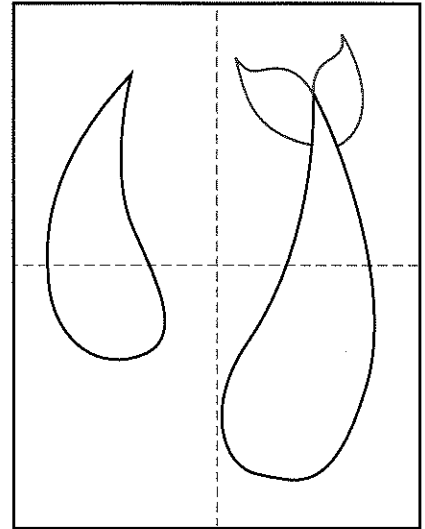

3. Add a tail to the large fish.

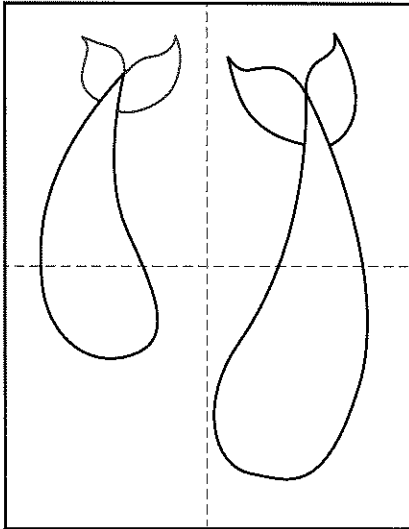

4. Add a tail to the small fish.

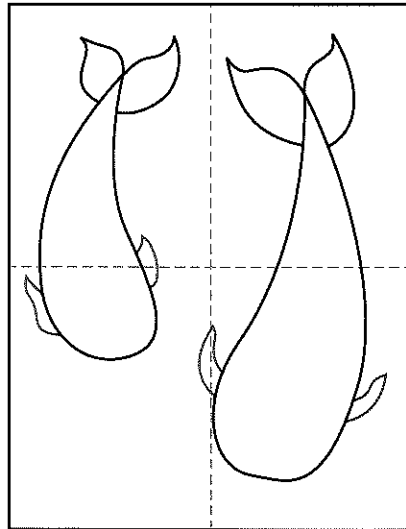

5. Add fins to both fish.

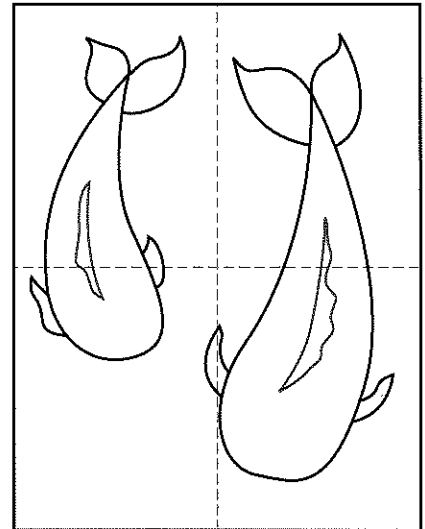

6. Draw a curved top fin on each.

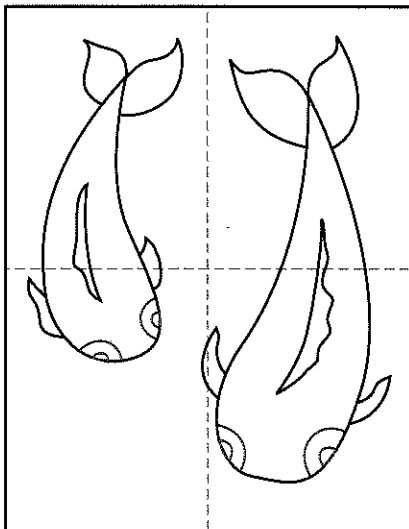

7. Draw the tops of the eyes.

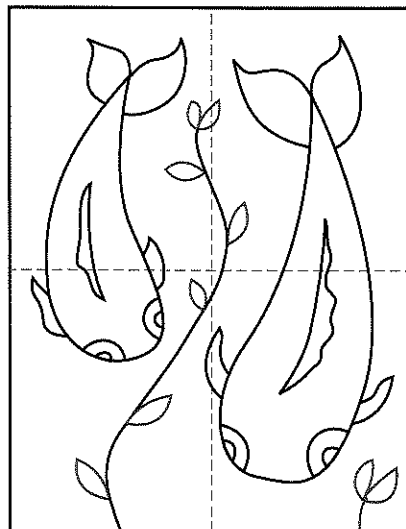

8. Add wavy plants in between.



9. Trace with crayons, color and paint.

# Draw a Windy Day

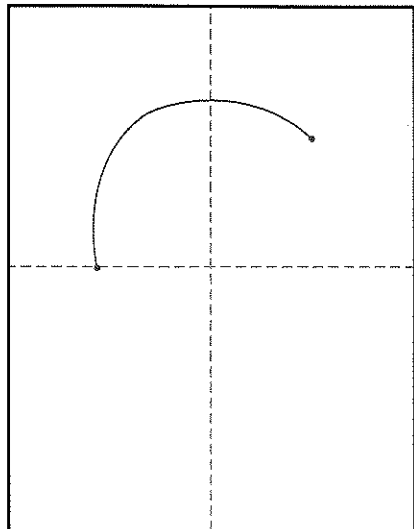

1. Draw guides. Draw dots, connect.

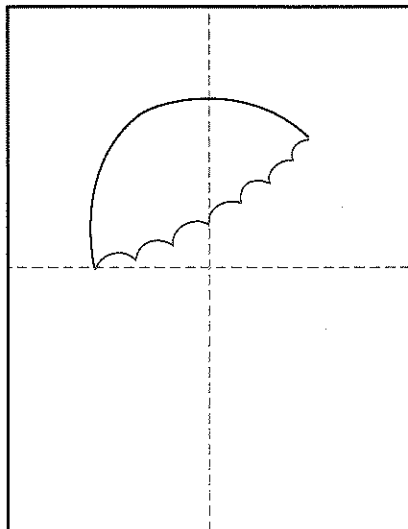

2. Draw umbrella bottom.

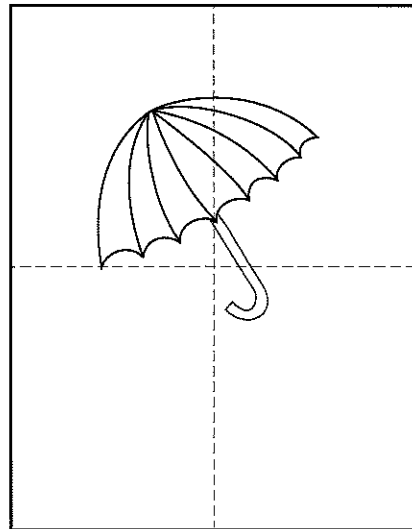

3. Draw umbrella handle.

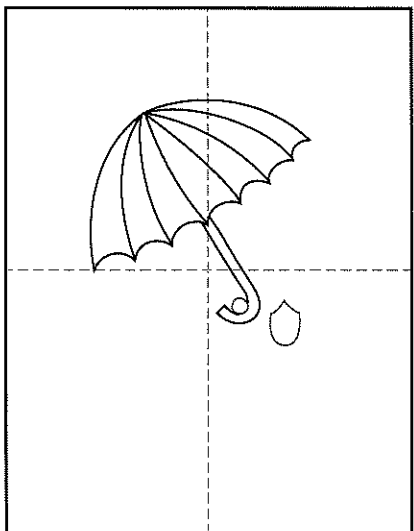

4. Add head and hand.

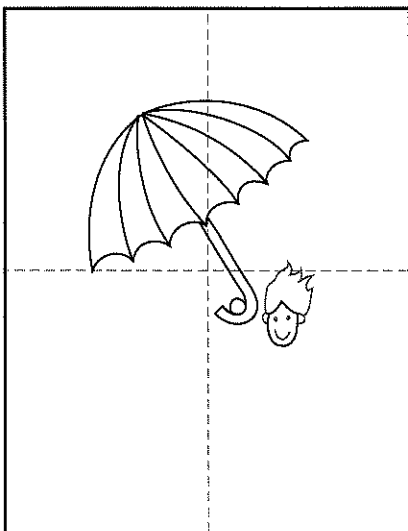

5. Draw windy hair, ears, face.

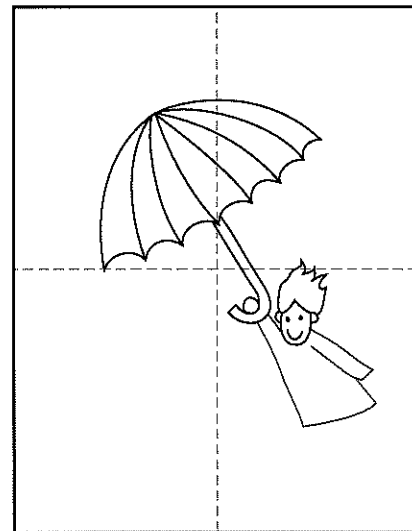

6. Draw a jacket.

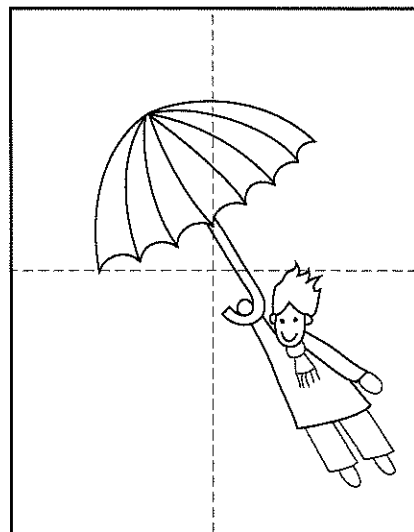

7. Add scarf, hand and legs.

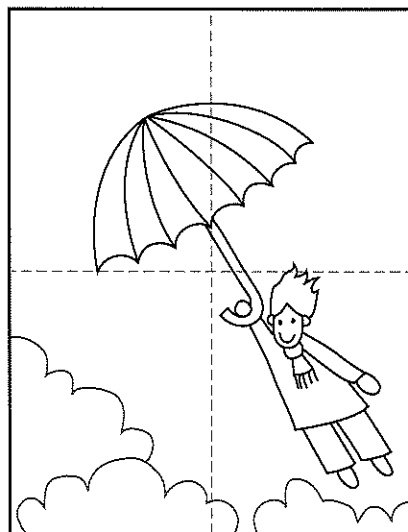

8. Finish with trees.



9. Trace with markers and color.

# Draw a Cartoon Dog

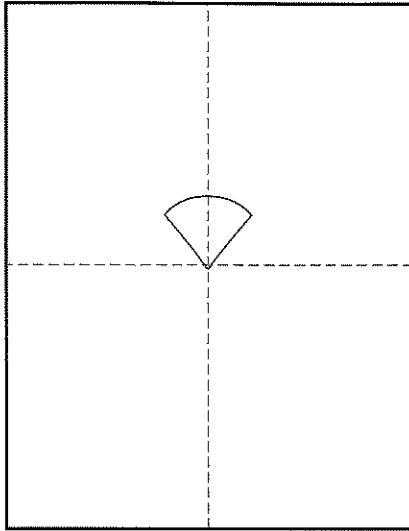

1. Make guide lines. Draw the nose.

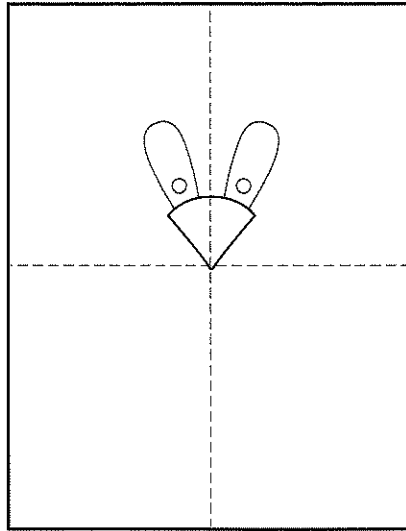

2. Draw two eyes.

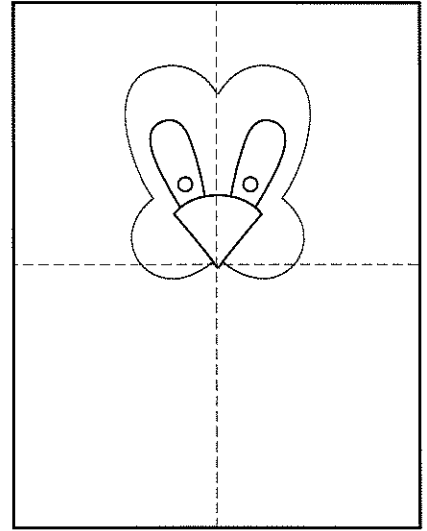

3. Draw face around eyes and nose.

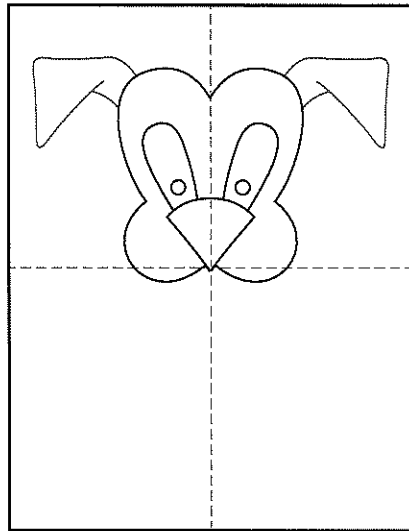

4. Draw two folded ears.

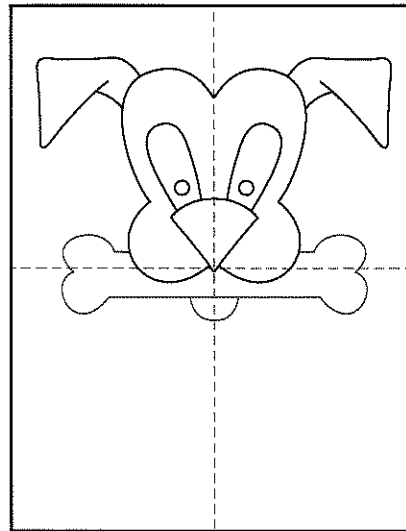

5. Draw bone and chin.

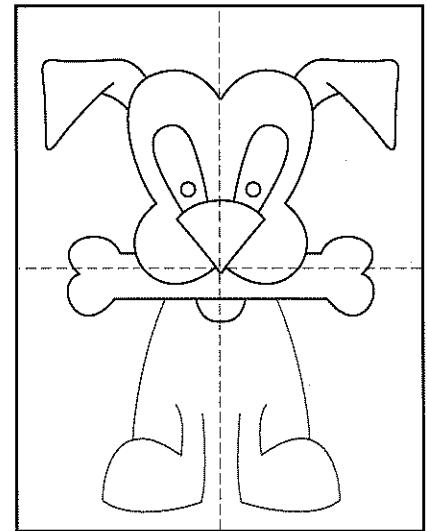

6. Add sides and front legs.

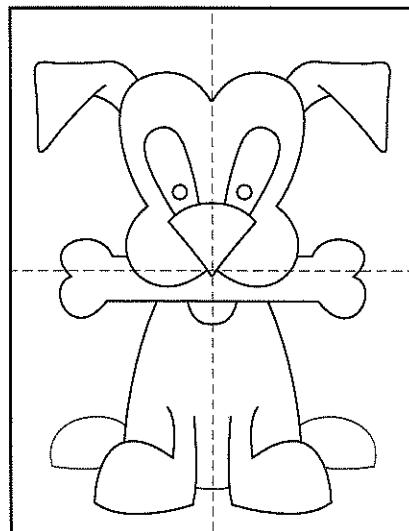

7. Add back feet and belly line.

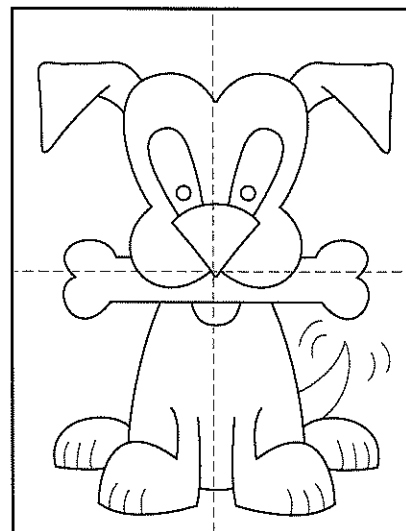

8. Finish with toenails and tail.

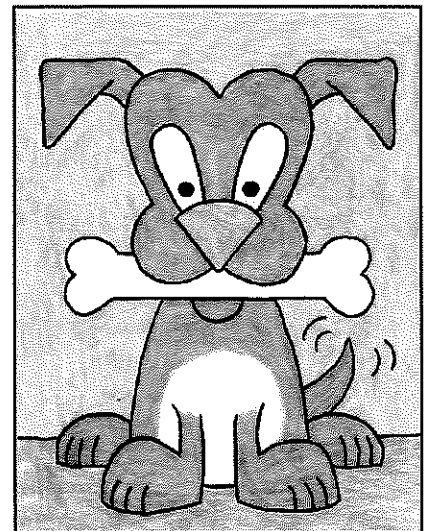

9. Trace with a marker and color.

# Draw a Chameleon

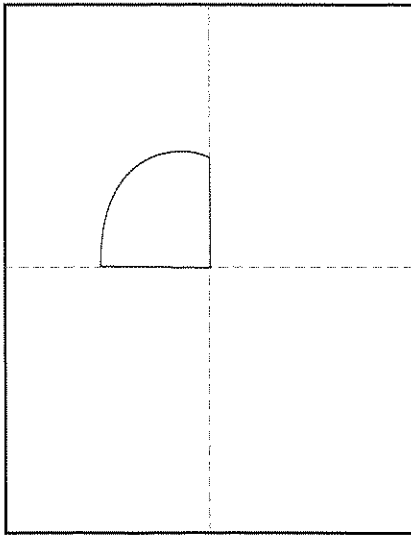

1. Draw a quarter circle for the head.

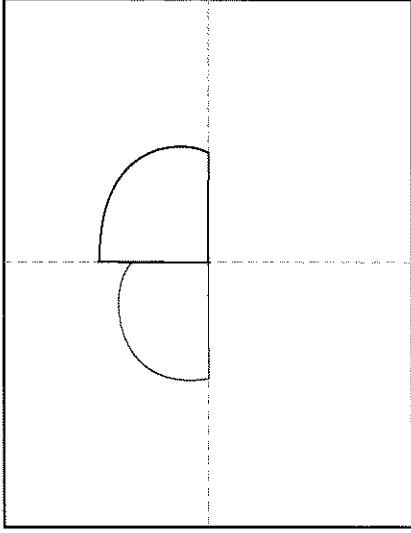

2. Draw a simple body to the left of it.

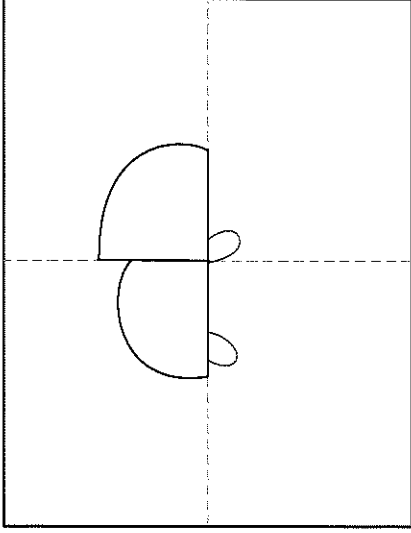

3. Draw two simple legs below.

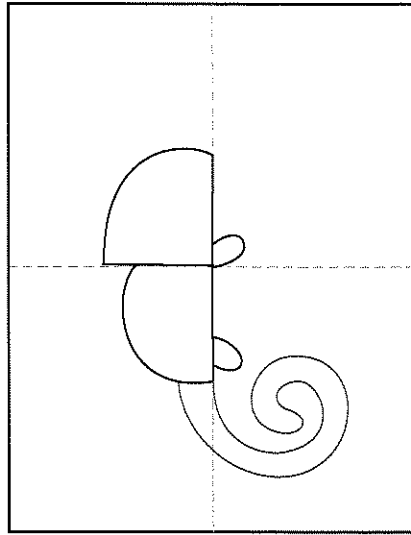

4. Add a curly tail.

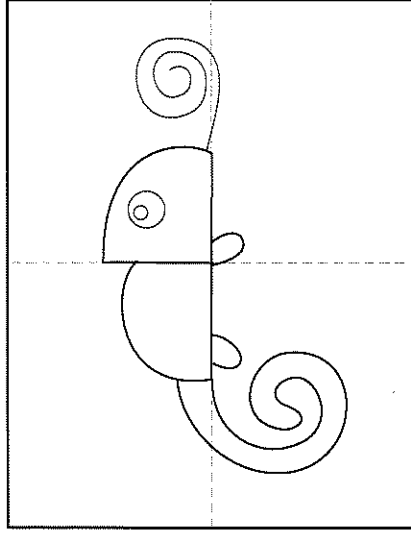

5. Draw an eye and curly line for the tongue.

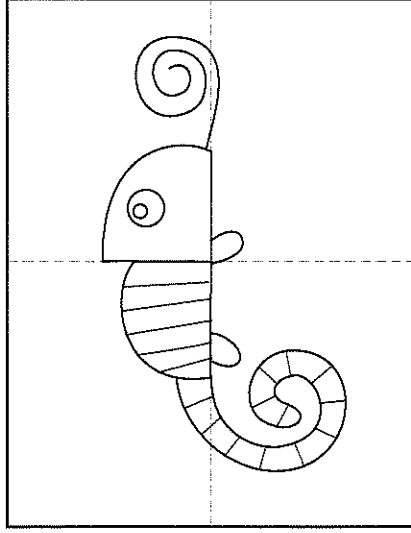

6. Add stripes to the body and tail.

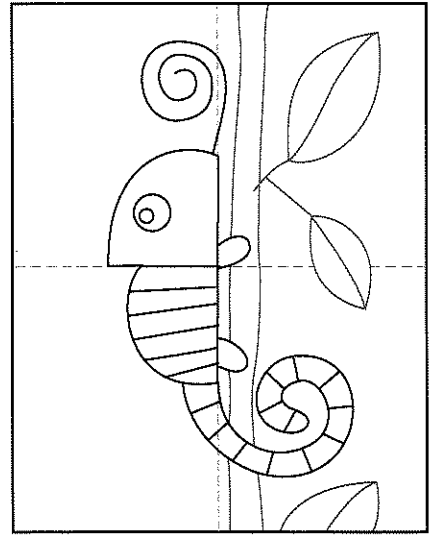

7. Draw a branch with leaves.

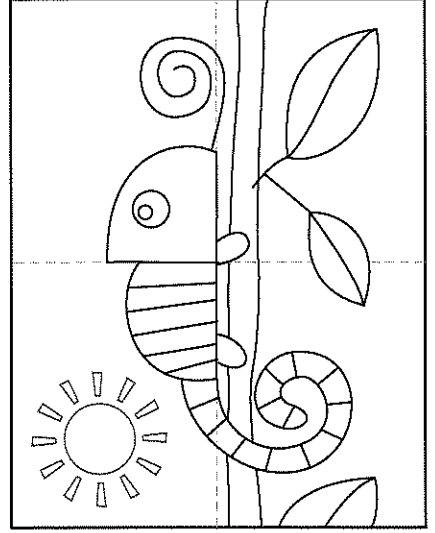

8. Add a sun in the background.

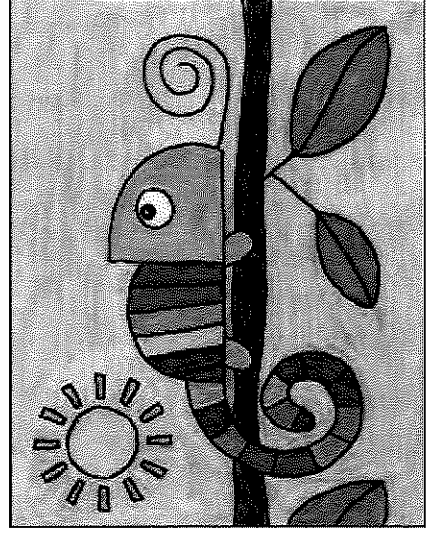

9. Trace with a marker and color.

# Draw a Super Easy Fox



Supplies: Black paper, oil pastels

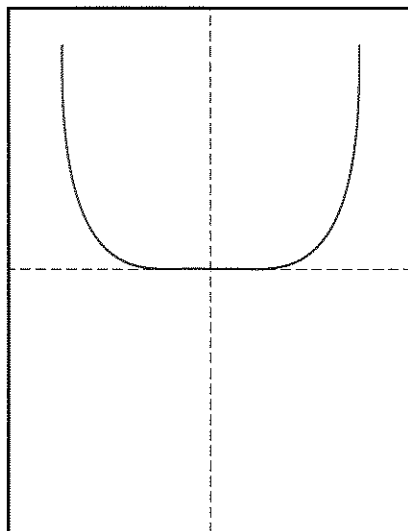

1. Make guide lines. Draw a U.

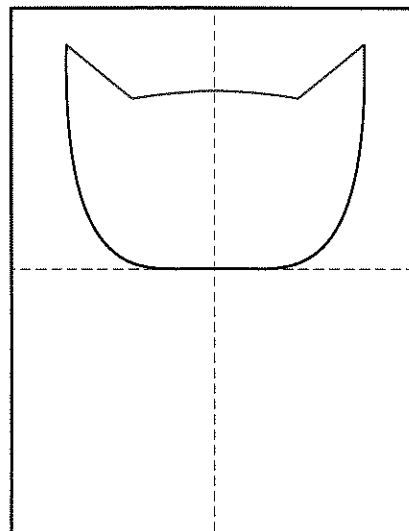

2. Connect top with ears.

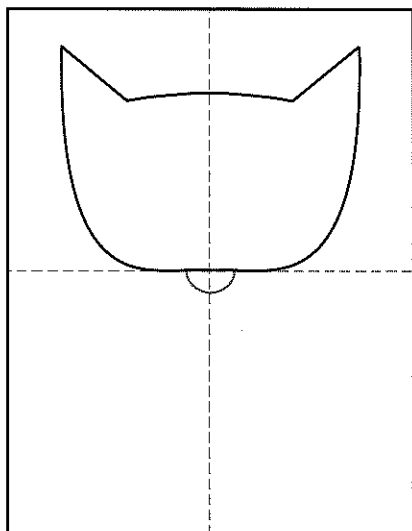

3. Draw a nose.

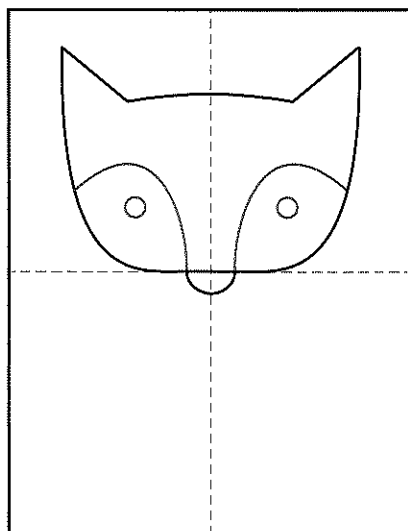

4. Add curved lines and eyes.

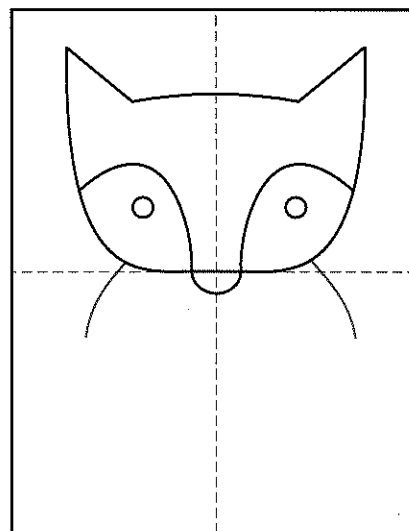

5. Start the shoulders.

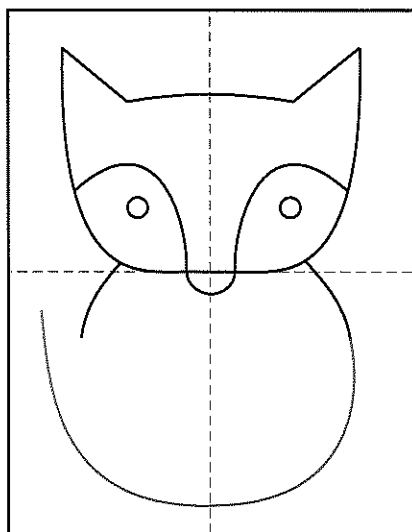

6. Continue the bottom line.

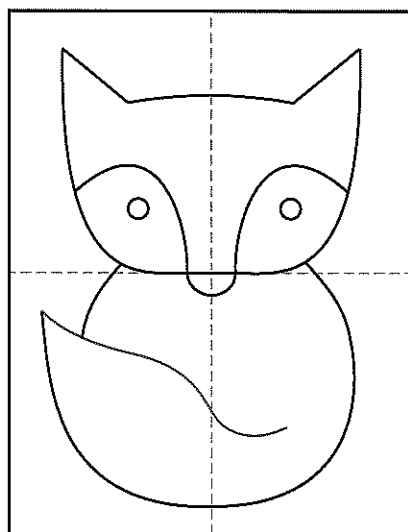

7. Finish the tail.

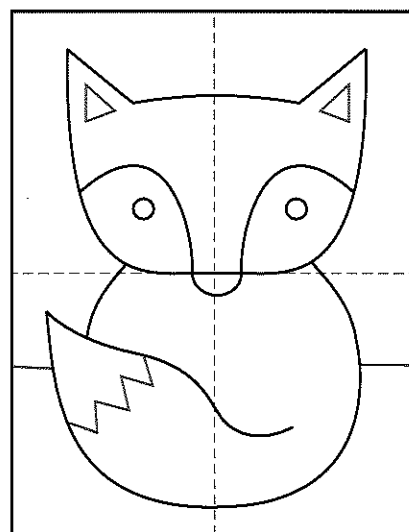

8. Add tail, ear details and horizon.